

ИНСТРУКЦИЯ ПО СБОРКЕ

ДЕТАЛИ

А. Столешница

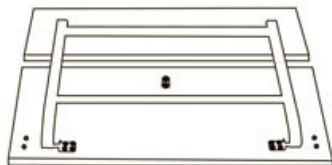

В. Левая нога

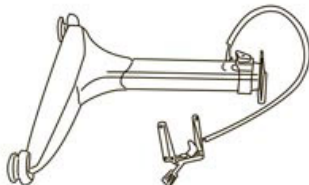

С. Правая нога

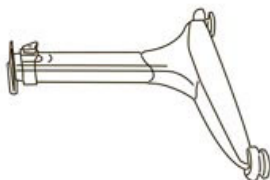

Д. Перекладина



Е. Накладки



Ф. Панель



Г. Пенал



Н. Газ-лифт



И. Большой ящик для канцтоваров



Ж. Крючки

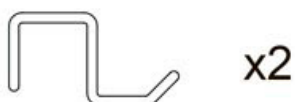

x2

1



M6×20mm

2



M6×13mm

3



M6×13mm

4



зажим

5



4x12mm

6



M8x20mm

7



M8

8



ключ в форме
треугольника

9



M4

10



M5

11



13mm

12



x4

4x12mm (саморезы)

13



x4

4x17mm

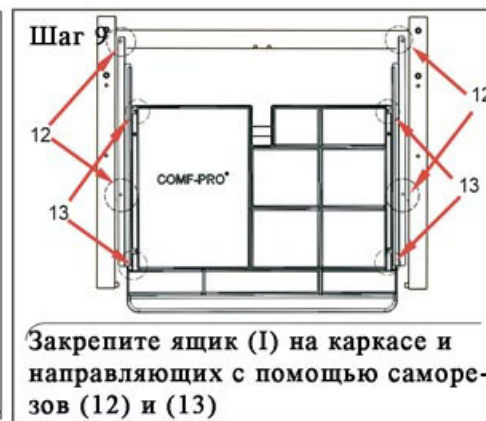
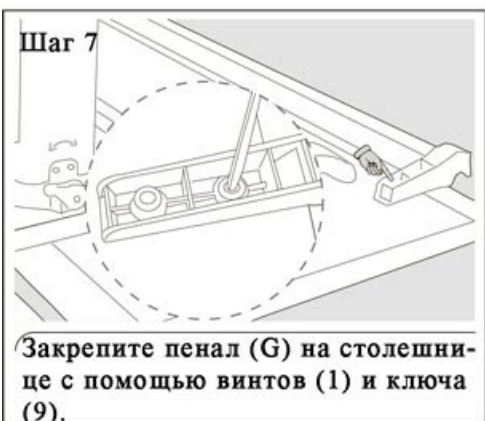
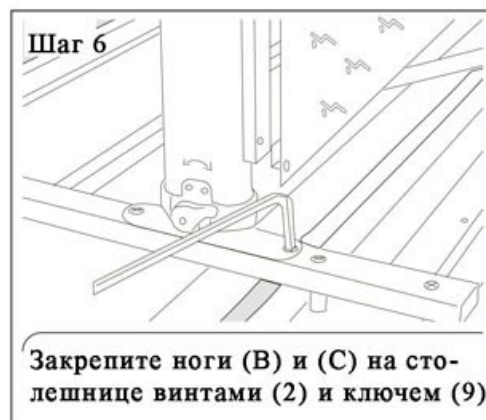
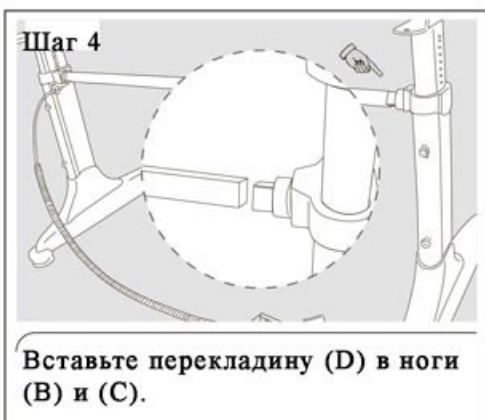
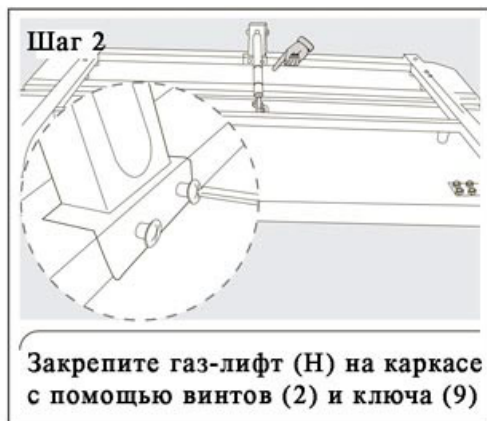

Проверьте крепко ли затянуты все винты

Повесьте крючки (J) на раму стола

ВНИМАНИЕ!

1. Проверяйте наличие всех деталей перед началом сборки
2. Перед использованием стола проверьте и затяните все винты

